

## TŁUMIK AKUSTYCZNY OKRĄGŁY

SLL

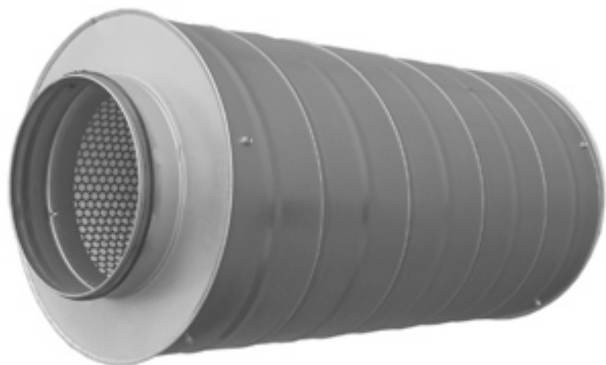

### ZASTOSOWANIE

Tłumiki akustyczne okrągłe przeznaczone są do tłumienia hałasu w instalacjach kanałów wentylacji i klimatyzacji.

### KONSTRUKCJA

Obudowa zewnętrzna wykonana jest z rury spiralnie zwijanej. Warstwę tłumiącą stanowi wełna mineralna, zabezpieczona od strony instalacji kanałowej tkaniną filtracyjną oraz ocynkowaną blachą stalową z perforacją. Króćce przyłączeniowe w wykonaniu z uszczelką.

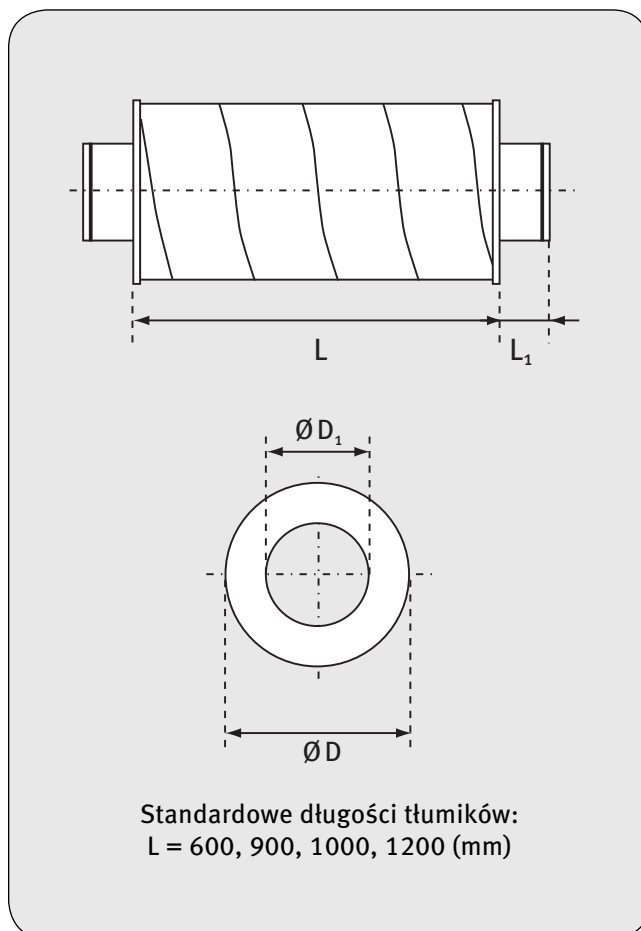

Tłumiki posiadają badania akustyczne wg normy ISO 7235

ØD1 (mm)	ØD (mm)		L1 (mm)
	dla izolacji 50 mm	dla izolacji 100 mm	
80	180	280	50
100	200	315	50
125	224	315	50
140	250	355	50
150	250	355	50
160	250	355	50
180	280	400	50
200	315	400	50
224	315	400	50
250	355	450	50

ØD1 (mm)	ØD (mm)		L1 (mm)
	dla izolacji 50 mm	dla izolacji 100 mm	
280	400	500	50
315	400	500	50
355	450	560	50
400	500	630	60
450	560	630	60
500	630	710	60
560	630	800	70
630	710	800	70
710	800	900	70
800	900	1000	70

Typ	Tłumienie [dB] dla częstotliwości [Hz]							
	63	125	250	500	1000	2000	4000	8000
SLL 100/50/1200	7	11	23	42	49	50	50	36
SLL 100/50/1000	5	10	18	32	48	50	50	30
SLL 100/50/900	5	10	17	31	43	50	47	28
SLL 100/50/600	5	8	12	23	35	48	40	21

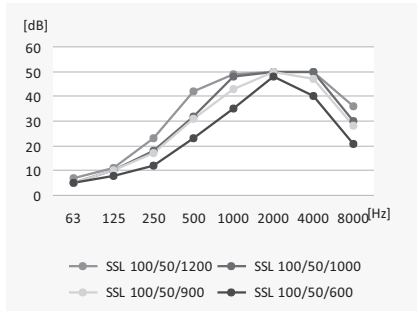

Typ	Tłumienie [dB] dla częstotliwości [Hz]							
	63	125	250	500	1000	2000	4000	8000
SLL 125/50/1200	4	9	18	33	47	50	49	26
SLL 125/50/1000	3	7	15	26	45	50	45	22
SLL 125/50/900	3	7	14	20	40	50	42	20
SLL 125/50/600	2	4	9	19	33	43	35	13

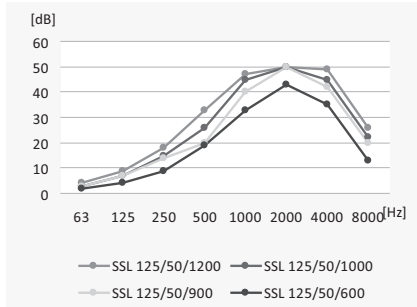

Typ	Tłumienie [dB] dla częstotliwości [Hz]							
	63	125	250	500	1000	2000	4000	8000
SLL 160/50/1200	4	7	14	26	40	45	34	16
SLL 160/50/1000	3	6	12	20	37	43	29	13
SLL 160/50/900	3	5	11	19	34	40	26	12
SLL 160/50/600	2	4	7	15	28	34	17	8

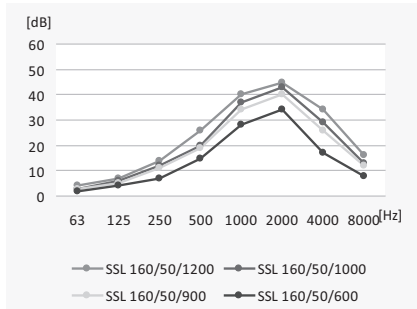

Typ	Tłumienie [dB] dla częstotliwości [Hz]							
	63	125	250	500	1000	2000	4000	8000
SLL 200/50/1200	2	5	12	22	38	35	23	12
SLL 200/50/1000	2	4	10	18	32	33	21	11
SLL 200/50/900	3	4	9	18	31	30	20	11
SLL 200/50/600	1	3	7	14	25	23	16	10

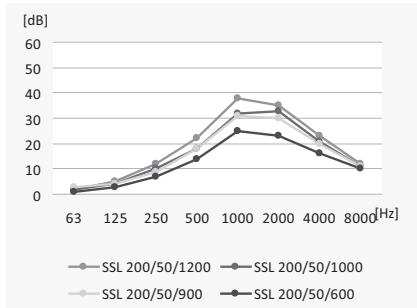

Typ	Tłumienie [dB] dla częstotliwości [Hz]							
	63	125	250	500	1000	2000	4000	8000
SLL 250/50/1200	1	3	10	21	33	26	17	9
SLL 250/50/1000	1	3	8	17	27	22	14	7
SLL 250/50/900	1	3	7	16	24	20	12	6
SLL 250/50/600	1	2	5	12	16	13	8	4

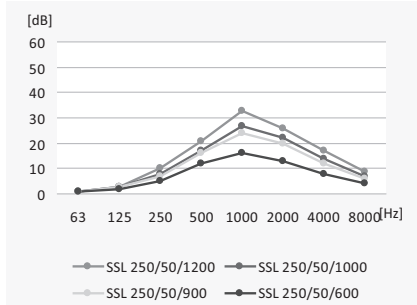

## Tłumiki akustyczne

Typ	Tłumienie [dB] dla częstotliwości [Hz]							
	63	125	250	500	1000	2000	4000	8000
SLL 315/50/1200	1	3	8	17	27	21	11	6
SLL 315/50/1000	1	2	6	16	22	17	9	5
SLL 315/50/900	1	2	6	15	20	15	8	5
SLL 315/50/600	0	1	4	11	14	10	5	3

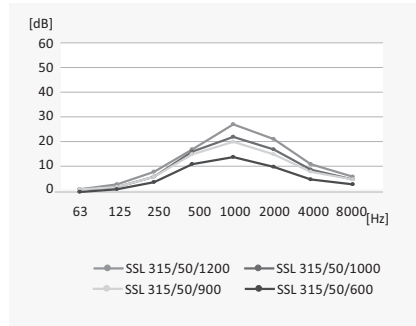

Typ	Tłumienie [dB] dla częstotliwości [Hz]							
	63	125	250	500	1000	2000	4000	8000
SLL 315/100/1200	3	8	19	32	34	19	5	1
SLL 315/100/1000	2	7	16	27	31	16	4	1
SLL 315/100/900	2	6	14	24	28	14	4	1
SLL 315/100/600	1	4	10	16	19	9	3	1

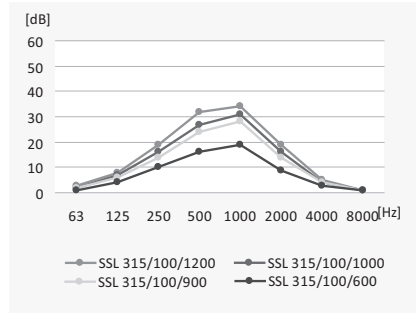

Typ	Tłumienie [dB] dla częstotliwości [Hz]							
	63	125	250	500	1000	2000	4000	8000
SLL 400/50/1200	0	2	6	15	22	7	7	4
SLL 400/50/1000	0	2	5	14	19	6	5	3
SLL 400/50/900	0	1	5	13	17	6	5	3
SLL 400/50/600	0	1	3	10	12	5	3	1

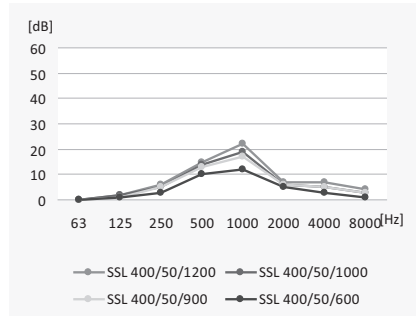

Typ	Tłumienie [dB] dla częstotliwości [Hz]							
	63	125	250	500	1000	2000	4000	8000
SLL 400/100/1200	3	6	15	27	23	8	5	3
SLL 400/100/1000	3	5	13	23	19	7	4	3
SLL 400/100/900	3	4	12	21	17	6	4	2
SLL 400/100/600	2	3	8	16	11	5	3	1

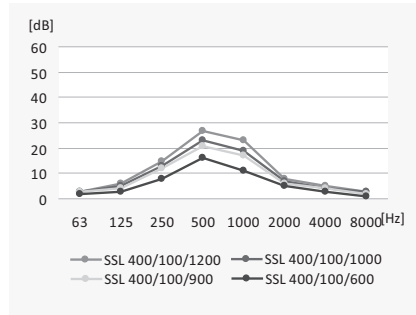

Typ	Ciśnienie [Pa]					Współczynnik sprawności
	2 [m/s]	4 [m/s]	6 [m/s]	8 [m/s]	10 [m/s]	
SLL 100/50/1200	1	4	8	15	23	0,39
SLL 100/50/1000	1	3	7	12	19	0,32
SLL 100/50/900	1	3	6	11	17	0,29
SLL 100/50/600	0	2	4	7	12	0,19

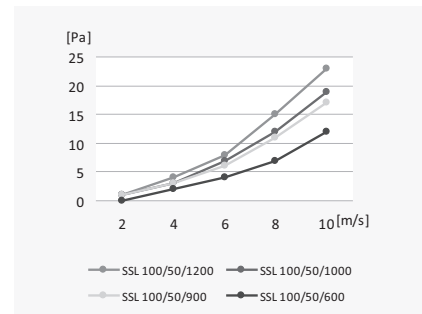

Typ	Ciśnienie [Pa]					Współczynnik sprawności
	2 [m/s]	4 [m/s]	6 [m/s]	8 [m/s]	10 [m/s]	
SLL 125/50/1200	1	3	6	11	18	0,29
SLL 125/50/1000	1	2	5	9	15	0,24
SLL 125/50/900	1	2	5	8	13	0,22
SLL 125/50/600	0	1	3	6	9	0,15

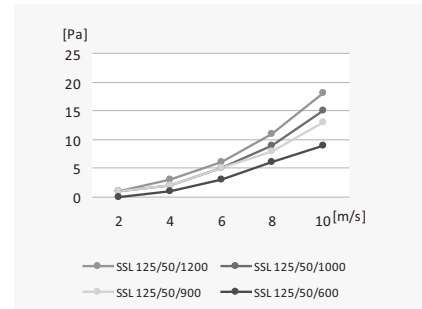

Typ	Ciśnienie [Pa]					Współczynnik sprawności
	2 [m/s]	4 [m/s]	6 [m/s]	8 [m/s]	10 [m/s]	
SLL 160/50/1200	1	2	5	8	13	0,22
SLL 160/50/1000	0	2	4	7	11	0,18
SLL 160/50/900	0	2	3	6	10	0,16
SLL 160/50/600	0	1	2	4	6	0,11

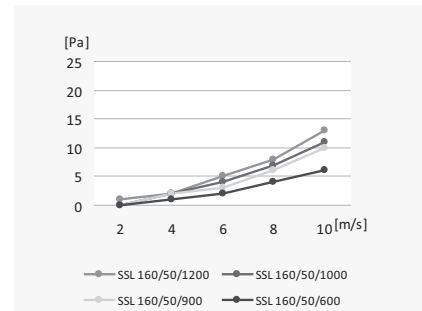

Typ	Ciśnienie [Pa]					Współczynnik sprawności
	2 [m/s]	4 [m/s]	6 [m/s]	8 [m/s]	10 [m/s]	
SLL 200/50/1200	0	2	4	6	10	0,16
SLL 200/50/1000	0	1	3	5	8	0,14
SLL 200/50/900	0	1	3	5	7	0,12
SLL 200/50/600	0	1	2	3	5	0,08

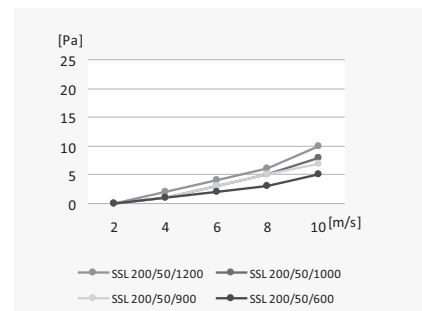

Typ	Ciśnienie [Pa]					Współczynnik sprawności
	2 [m/s]	4 [m/s]	6 [m/s]	8 [m/s]	10 [m/s]	
SLL 250/50/1200	0	1	3	5	7	0,12
SLL 250/50/1000	0	1	2	4	6	0,10
SLL 250/50/900	0	1	2	4	6	0,09
SLL 250/50/600	0	1	1	2	4	0,06

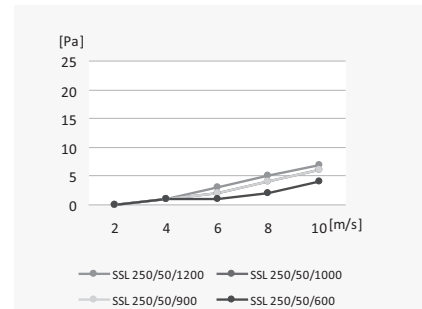

## Tłumiki akustyczne

Typ	Ciśnienie [Pa]					Współczynnik sprawności
	2 [m/s]	4 [m/s]	6 [m/s]	8 [m/s]	10 [m/s]	
SLL 315/50/1200	0	1	2	4	6	0,09
SLL 315/50/1000	0	1	2	3	5	0,08
SLL 315/50/900	0	1	1	3	4	0,07
SLL 315/50/600	0	0	1	2	3	0,05

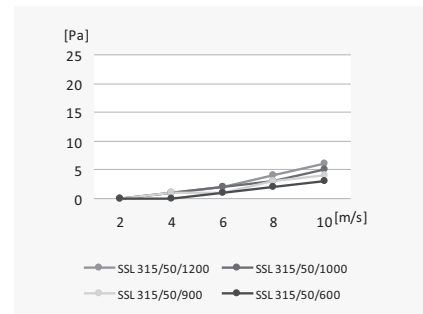

Typ	Ciśnienie [Pa]					Współczynnik sprawności
	2 [m/s]	4 [m/s]	6 [m/s]	8 [m/s]	10 [m/s]	
SLL 400/50/1200	0	1	1	3	4	0,07
SLL 400/50/1000	0	1	1	2	3	0,06
SLL 400/50/900	0	0	1	2	3	0,05
SLL 400/50/600	0	0	1	1	2	0,03

